

# ASSEMBLY AND INSTALLATION INSTRUCTIONS

P0346

**WARNING:** TO AVOID RISK OF ELECTRICAL SHOCK, BE SURE TO SHUT OFF POWER BEFORE INSTALLING OR SERVICING THIS FIXTURE.

**NOTE:** 1. Before installing, consult local electrical codes for wiring and grounding requirements.  
2. READ AND SAVE THESE INSTRUCTIONS.

## Hardware Package(inculded):

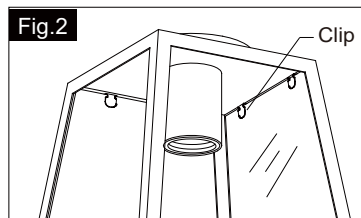
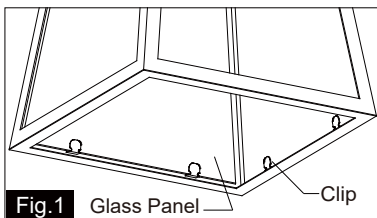
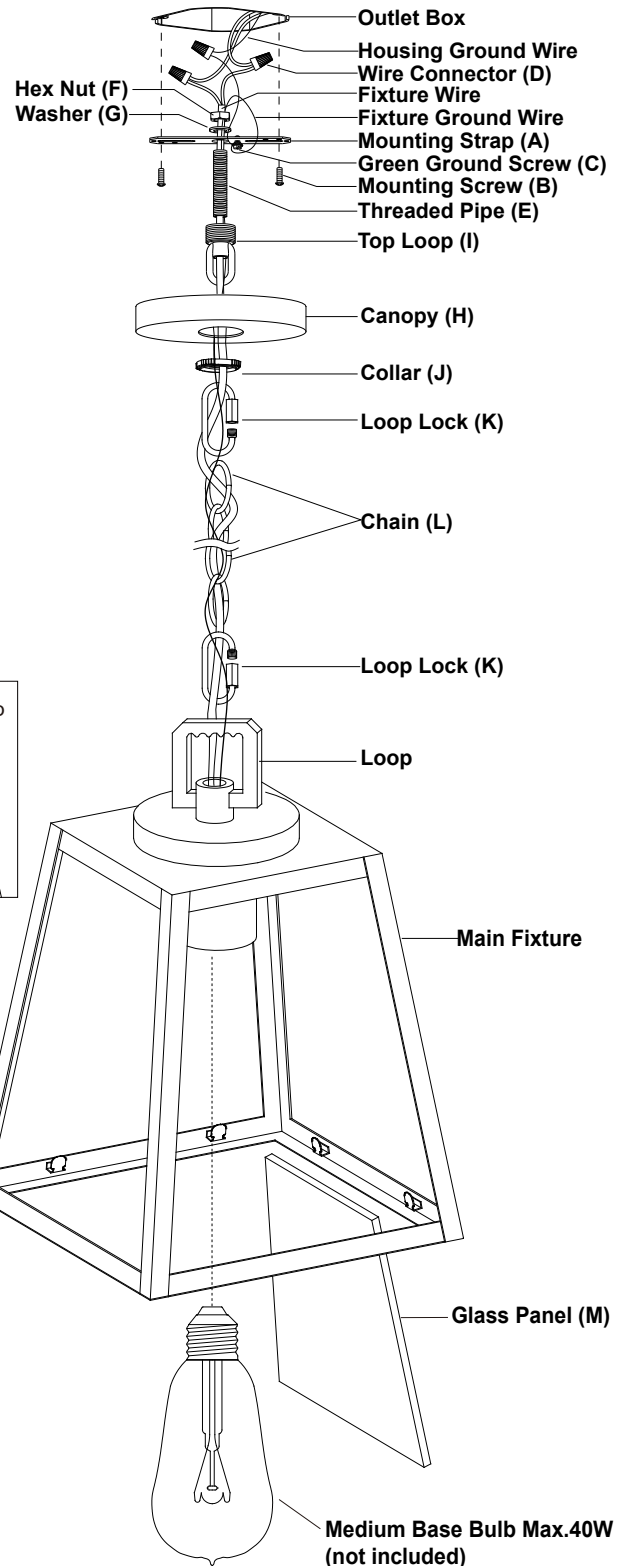
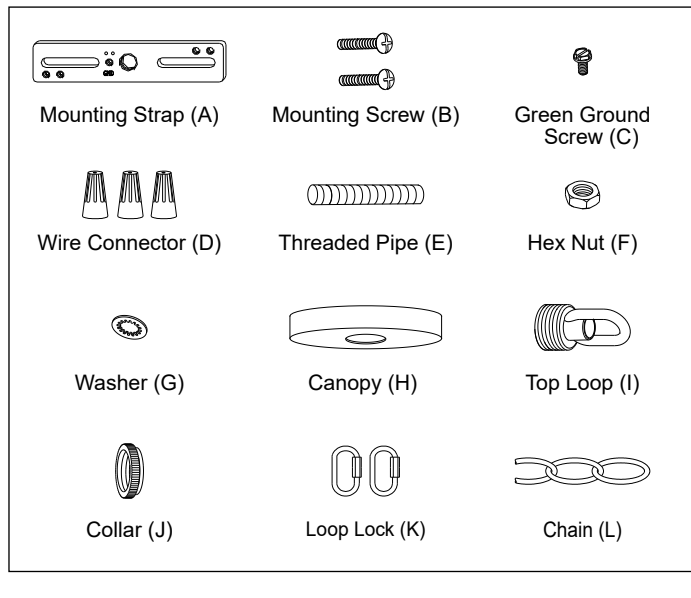

## Installation Steps

Turn off the power at fuse or circuit box.











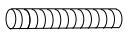

1. Attach threaded pipe (E) to the mounting strap (A), then secure it with a washer (G) and hex nut (F).
2. Attach the mounting strap (A) to the outlet box by using two mounting screws (B).
3. Secure the top loop (I) to threaded pipe (E).
4. Take a glass panel and gently slide the narrow side of the glass panel down into the metal frame in place, secure it by pressing the clips from both top and bottom sides. (See Fig.1 & Fig.2) Repeat with other panels.

5. Choose the length of the chain (L) you need, then weave the fixture wire and the fixture ground wire through the chain (L), collar (J) and canopy (H).
6. Connect one end of the chain (L) with the loop by using a loop lock (K).
7. Connect the other end of the chain (L) with the top loop (I) by using another loop lock (K).
8. Thread the fixture wire and fixture ground wire through the top loop (I), threaded pipe (E) and mounting strap (A).
9. Pull out the outlet wires and house ground wire from the outlet box. Make wire connections using the wire connectors (D):
  - The smooth wire (marked) from the fixture to the black wire from the power source.
  - The ridged wire (unmarked) from the fixture to the white wire from the power source.
  - Attach the fixture ground wire to the mounting strap (A) with the green ground screw (C). Then connect it to the house ground wire with a wire connector (D).
 Carefully put the wires back into the outlet box.
10. Attach the canopy (H) to the mounting strap (A) by inserting the top loop (I), then secure it with the collar (J).
11. Install bulbs (not included). See relamping label at socket area or packaging for maximum wattage allowed .

**Turn on the power at fuse or circuit box.**

The following parts are available for re-order if damaged or missing.

**Spare Parts List:**

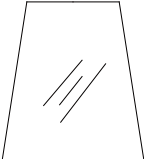
 Mounting Strap (A)	 Mounting Screw (B)	 Green Ground Screw (C)	 Wire Connector (D)	 Mounting Hardware 6276MM(1 SET)	
 Threaded Pipe (E)	 Hex Nut (F)	 Washer (G)	 Canopy (H)		 Chain (L) 3219CB
 Top Loop (I)	 Collar (J)	 Loop Lock (K)			 Glass Panel (M) 9441CE

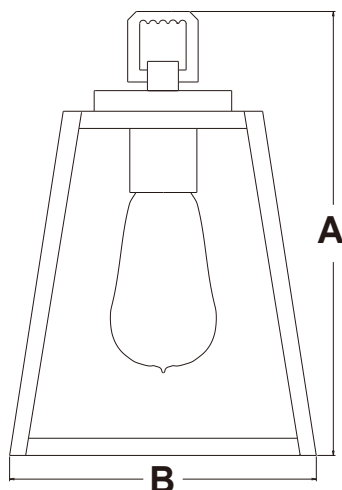

**A: 10-1/4"**

**B: 7"**